

VA209

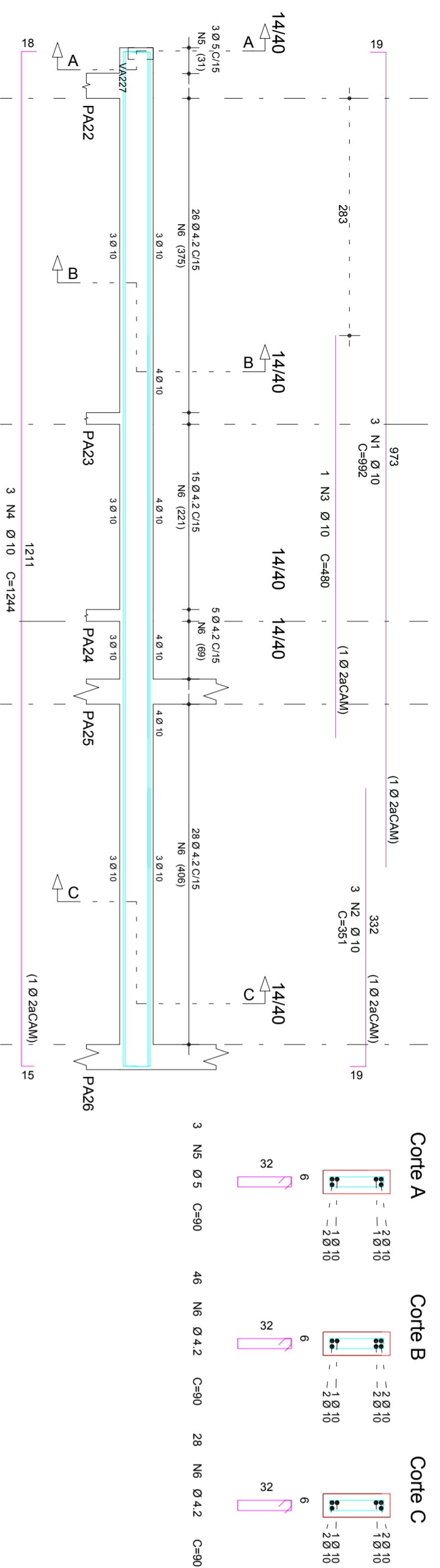

VA238

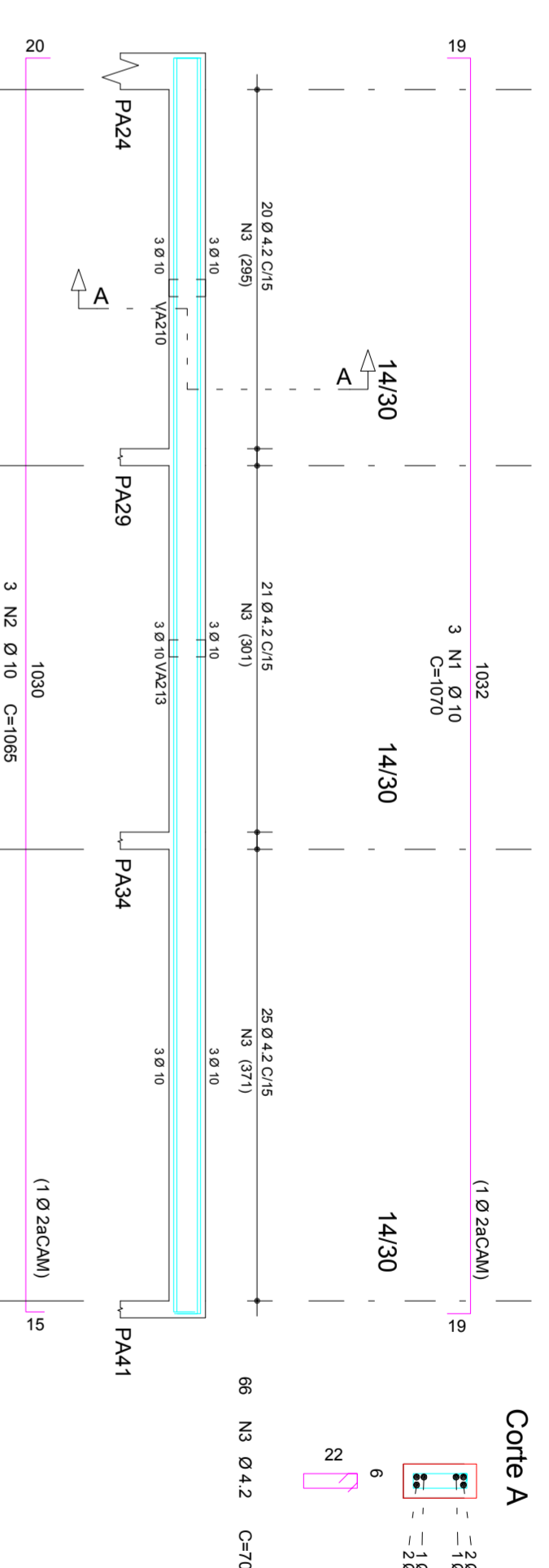

VA203

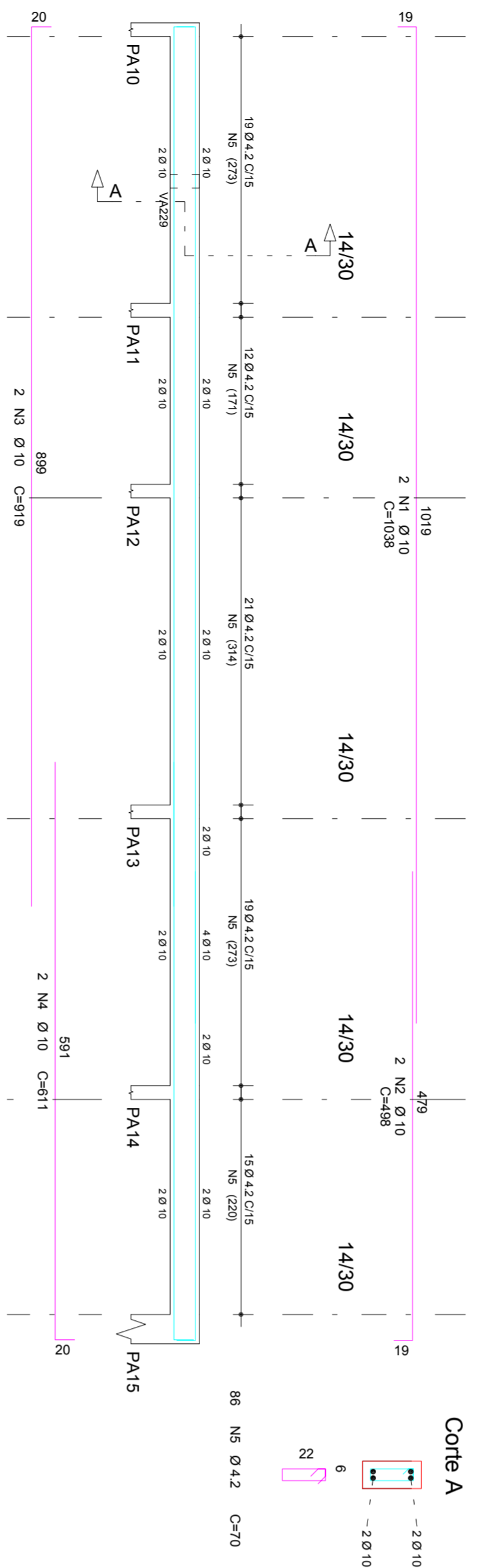

VA201

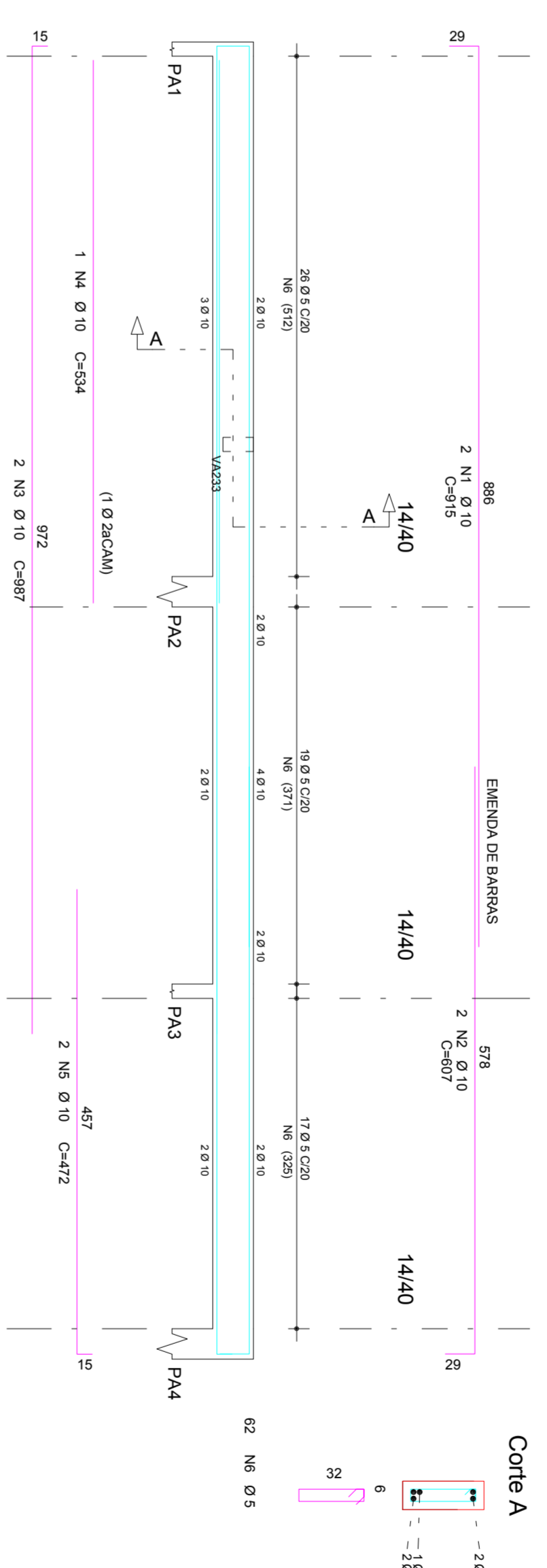

VA202

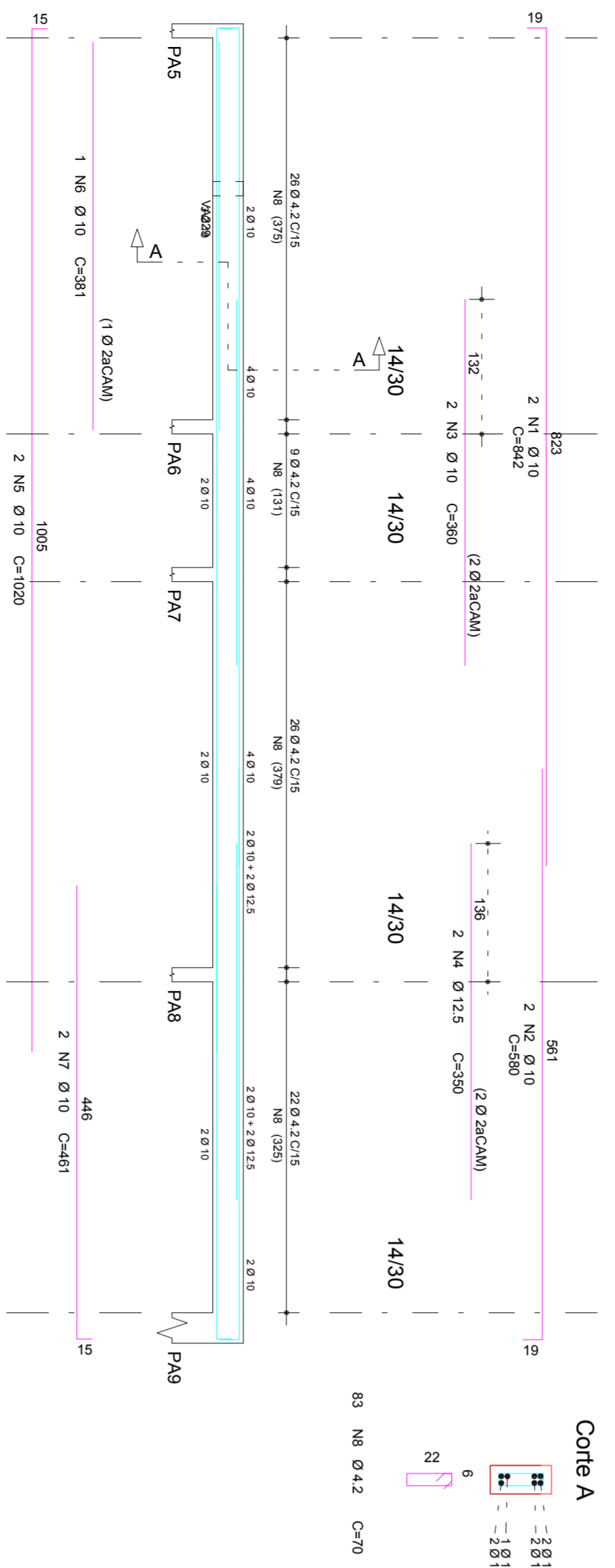

VA225

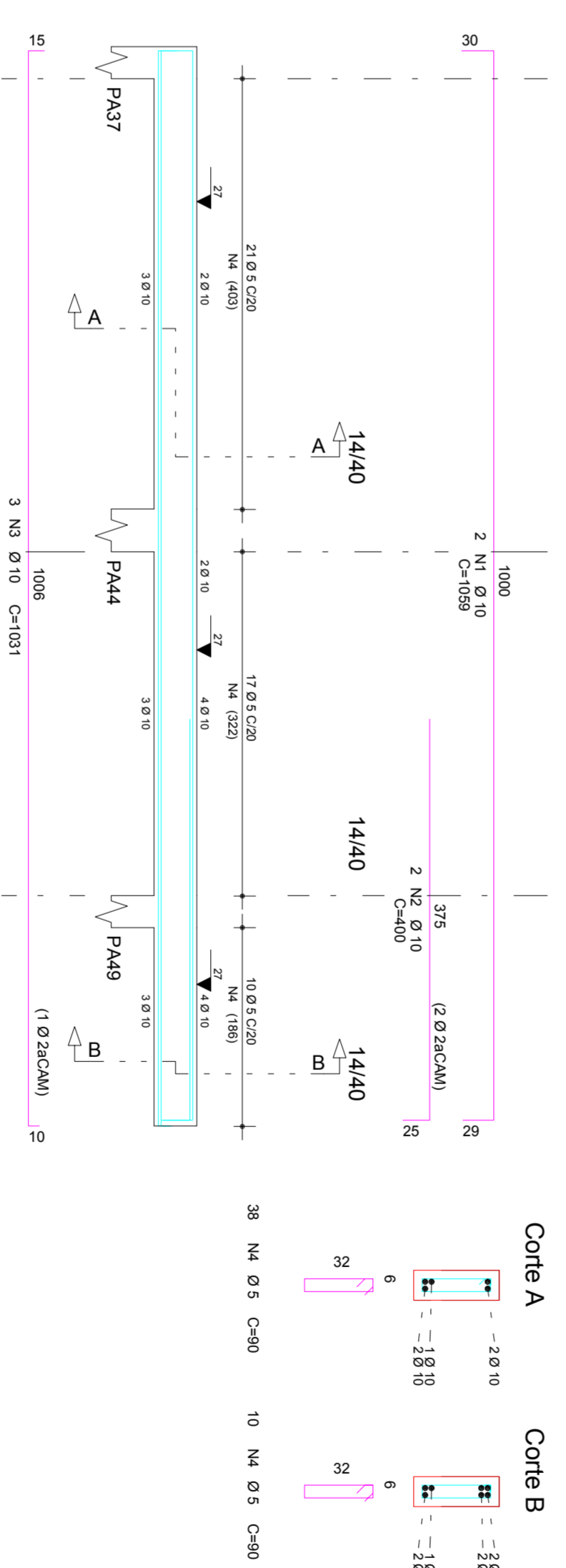

VA244

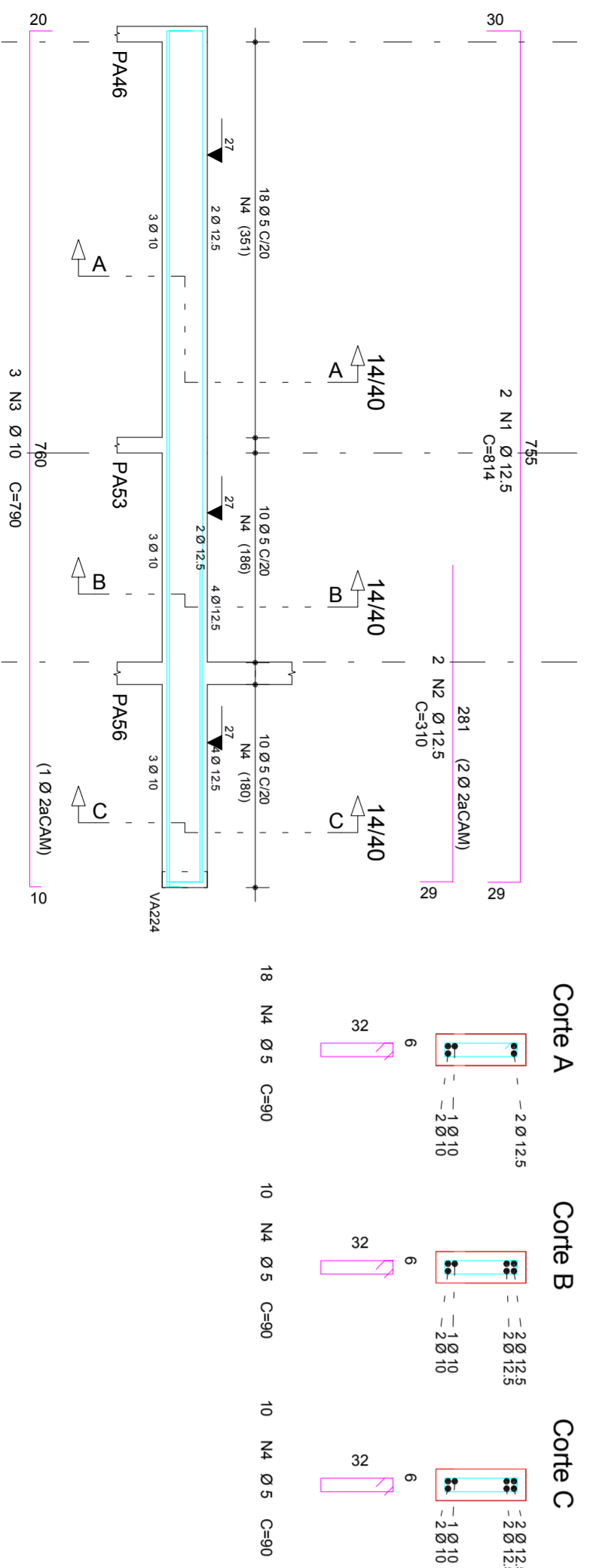

VA218

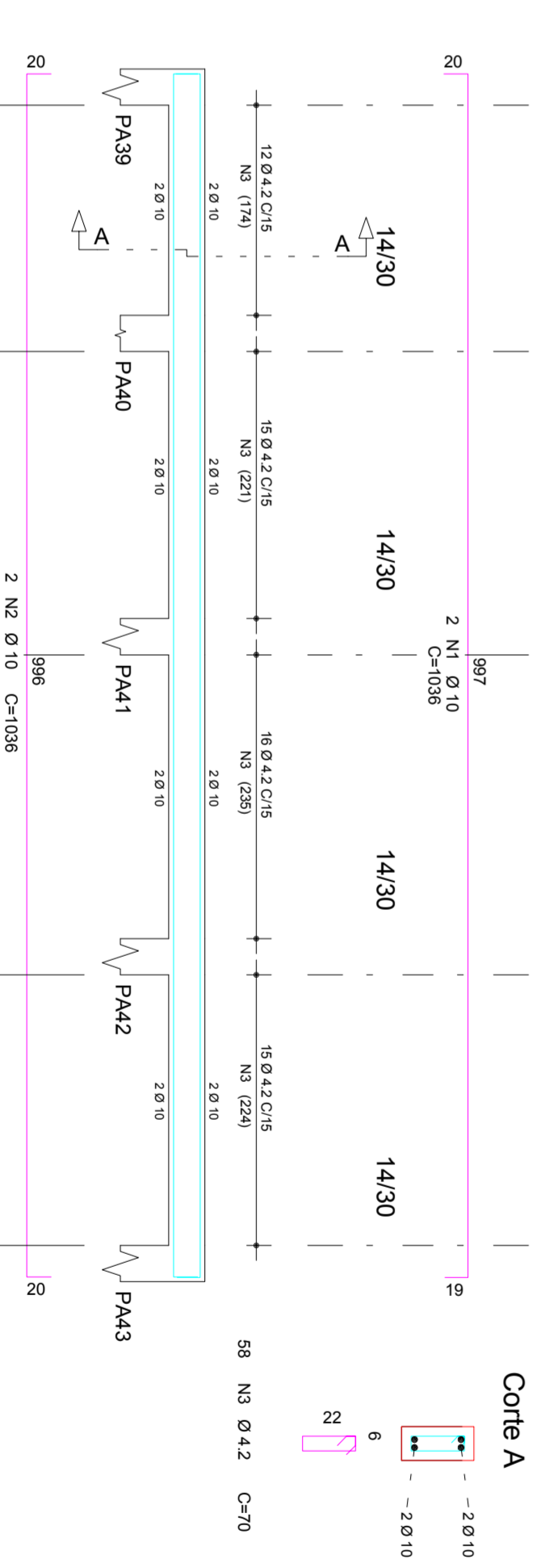

ACO	POS	BIT (mm)	QUANT	COMPRIMENTO (cm)	UNID	TOTAL (cm)
VA201	50A	1	10	2	915	1830
	50A	2	10	2	607	1214
	50A	3	10	2	987	1974
	50A	4	10	1	534	534
	50A	6	5	62	50	5690
VA202	50A	1	10	2	842	1684
	50A	2	10	2	580	1160
	50A	4	12.5	2	700	1400
	50A	5	10	2	1020	2040
	50A	6	10	1	381	381
VA203	50A	1	10	2	461	922
	50A	2	10	2	50	50
	50A	3	10	2	1038	2076
	50A	4	10	2	919	1838
	50A	5	4.2	86	70	6020
VA209	50A	1	10	2	1038	2076
	50A	2	10	2	1038	2076
	50A	3	4.2	58	70	4080
	50A	4	10	2	1038	2076
	50A	5	4.2	86	70	6020
VA218	50A	1	10	2	1038	2076
	50A	2	10	3	351	1053
	50A	4	10	3	1244	3732
	50A	5	5	3	90	270
	50A	6	4.2	74	90	6660
VA225	50A	1	10	2	1038	2118
	50A	2	10	3	1038	3114
	50A	3	10	3	1038	3114
	50A	4	5	48	90	4320
	50A	5	4.2	86	90	7740
VA238	50A	1	10	3	1070	3210
	50A	2	10	2	1038	2076
	50A	3	10	2	1038	2076
	50A	4	10	2	1038	2076
	50A	5	4.2	86	90	7740
VA244	50A	1	12.5	2	310	620
	50A	2	12.5	2	780	1560
	50A	3	10	3	1038	3114
	50A	4	5	38	90	3420
	50A	5	4.2	86	90	810

ACO	BIT (mm)	COMPR (cm)	QUANT	RESUMO ACO CA 50-60	PREÇO (R\$)
608	4.2	272	30	1038	3114
608	5	138	22	1038	2384
50A	10.5	487	29	1038	2991
50A	10.5	29	29	1038	2991
Resumo Total	608 =		51 kg		32419
Resumo Total	50A =		324 kg		

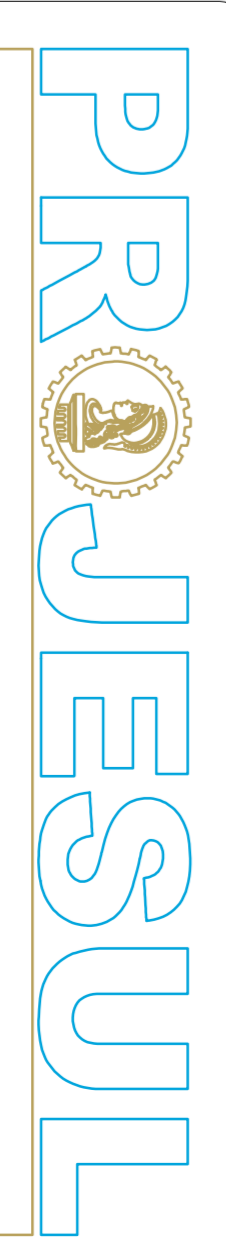

PROJETO ESTRUTURAL
UNIDADE DE PRONTO ATENDIMENTO 24H

CLIENTE: PREFEITURA MUNICIPAL DE MATINHOS
TÍTULO: UNIDADE DE PRONTO ATENDIMENTO 24H
CALCULISTA: MARCELO FARINHA
PROJETADE: MARCELO FARINHA

DATA: 07/07/2014
ESCALA: 30MP/30
REV. N.º: 00